



Cipher–Plexus Capital Advisors Pvt. Ltd.

www.cipherplexus.in

Overview

Cipher-Plexus Capital



- › Headquartered in Mumbai, Cipher-Plexus was formed with the integration of Cipher Capital & Plexus Ventures
- › Rich experience of three decades provides significant edge to protect & serve the best interests of its clients

- › Diversity of experience coupled with global reach & a culture founded on virtues enhances the ability to deliver superior value
- › 15+ Team members and Partners have been part of bulge-bracket investment banks

- › Insights from over 100+ successful transactions consummated across sectors, sizes, stages & complexities

Insights of over three decades and over 100+ successful deal closures ...

Business & Services

Private Equity

We enjoy a wide reach of high quality relationships and an admirable reputation with some of the most respected and sought after investors.

Our close interactions with all significant private equity and venture capital investors on an ongoing basis have helped us develop a deep understanding of their culture, functioning, investment philosophy and preferences. This facilitates the most appropriate investor-company fit towards delivering the best value in the given context.

Strong execution orientation & capabilities help us culminate difficult and complex transactions successfully & speedily.

Services Offered

- Growth/Expansion Capital
- Equity Financing
- Mezzanine Funding
- PIPEs
- Secondary Funding
- Special Situation Funding
- Buyouts
- Acquisition Financing

Select Transactions

<p>lifesigns Lifesigns Med Tech Investment by HealthQuad HealthQuad</p>	<p>ZEROHARM SCIENCE ZeroHarm Sciences Pvt Ltd Nutraceuticals Investment by kotak alkemi Kotak Alternate Asset Managers & Alkemi Growth Capital</p>	<p>curelo Curelo Health Healthcare & Lifesciences Investment by Family Offices / HNI</p>	<p>lifesigns Lifesigns Med Tech Investment By Family Office / HNI</p>	<p>Ibus Networks enabling data enterprise Ibus Networks & Infrastructure Network & Infrastructure Investment By Morgan Stanley Morgan Stanley Infra Fund</p>	<p>Sahyadri HOSPITALS Sahyadri Hospitals Multiple Specialty Hospitals Investment by IDFC IDFC Project Equity</p>
<p>Ibus Networks enabling data enterprise Ibus Networks & Infrastructure Network & Infrastructure Investment By NOMURA Nomura</p>	<p>Marck Marck Biosciences Pharmaceuticals - Sterile Liquids Investment by TATA CAPITAL Private Equity Tata Capital Healthcare Fund I</p>	<p>JMT AUTO JMT AUTO Auto Ancillaries Investment by CHRYSCAPITAL Chryscapital</p>	<p>UEM UEM Group Water Treatment EPC Investment by INDIA VALUE FUND India Value Fund</p>	<p>MTR MTR Foods Processed Indian Food Investment by AQUARIUS INVESTMENT ADVISORS PTE. LTD. Aquarius (Singapore) & Associates</p>	<p>Rubicon Research Rubicon Research Pharmaceutical R&D and Outsourcing Investment by kotak Private Equity Kotak Private Equity Group</p>
<p>Adigas Adiga's Group Quick Service Restaurants Investment by nsr new silk route GROWTH CAPITAL New Silk Route</p>	<p>ACT Atria Convergence Technologies Digital Cable Distribution Investment by INDIA VALUE FUND India Value Fund</p>	<p>BKT Balkrishna Industries Specialty Tyres Investment by EVERCORE PARTNERS Evercore</p>	<p>MOL CHEMISTRY OF SUCCESS AT WORK Meghmani Organics Limited Ahmedabad, India Agro-chemicals, Dyestuff and Intermediates Investment by Rajasthan Global Securities Pvt Ltd</p>	<p>BGR ENERGY BGR Energy Systems Turnkey Engineering & Equipment Supply Investment by citi Citibank Private Equity</p>	<p>WARBURG PINCUS Warburg Pincus & Mahansarias Off-Highway Tyres Financial Advisor for Financing & Acquisition of ATG ALLIANCE TYRE GROUP Alliance Tyre Company</p>

Select Relationships

ASCENT CAPITAL



BARING PRIVATE EQUITY PARTNERS INDIA



THE CARLYLE GROUP



Creador®



EVERSTONE



Goldman Sachs



KKR



Morgan Stanley
Global Private Equity



MULTIPLES

NORWEST VENTURE PARTNERS



SAIFPartners®



SEQUOIA



TATA CAPITAL
Private Equity

TEMASEK



WARBURG PINCUS

Mergers and Acquisitions

We represent clients on the sell-side as well as buy-side leveraging our deep relationships, rich experience and insights in managing complex cross border and domestic transactions.

The team has a strong domain focus and knowledge of the ecosystem that coupled with our expertise in structuring help us unlock the true potential in each transaction. We work skilfully with a diverse set of banks, investors, other financial sponsors and agencies to consummate the transaction efficiently.

We have strong relationships in India, US, Europe, Japan, and Middle East which help in zeroing on to the right potential targets for the clients.

Services Offered

Domestic sell-side and buy-side transactions

Cross border M&A representing sell-side as well as buy-side

Divestitures and Spin-offs

Carve-outs

Strategic Alliances

Joint Ventures

Management Buy-outs



Leveraged Buy-outs



Management Buy-ins

Select Transactions

TGPEL
PRECISION ENGINEERING LIMITED
Precision Engineering
Acquired by

SHRIRAM PISTONS & RINGS LTD.

Ibus Networks & Infrastructure
Network & Infrastructure
Acquired

D-Vois

Bloom Hospitals
Hospital
Acquired by

Ankura Hospitals

Ibus Networks & Infrastructure
Network & Infrastructure
Acquired

Ubico Networks

Equinox Solutions USA
Software Solutions
Acquired by

Cybertech Systems

Electracard Services
Payments Technology & Processing
Strategic Investment by

Mastercard Worldwide

Result International Systems USA
IT Enabled Services
Acquired by

Fiserv Inc.

Bristlecone Inc. USA
IT Consulting & Services
Majority holding acquired by

Mahindra Mahindra Group

Career Launcher
Inspiring leadership
Education, Training, Research & Consultancy
Acquired
KITS
Arun Roy Classes
Lohana Test Series
Compass Box
Law School Tutorials

Optimum Solutions
empowering business with technology
IT Solutions and Services
Investment by

Abeam Consulting

Warburg Pincus & Mahansarias
Off-Highway Tyres
Financial Advisor, Financing & Acquisition of

Alliance Tyre Company

Equinox Corp. USA
Business Process Outsourcing
Acquired by

iFlex Solutions

Ghari Group
Detergents & Soaps FMCG
Corporate Advisory

Orient Green Power Company Limited
Chennai, India
Renewable Energy
Sale of Co-gen Power Plant to DY Patil

Windsor Sathyan
Wastewater Evaporator Manufacturing
Strategic Investment By

Arvind Group

Structured Funding and Debt Advisory

Our Debt Advisory team specialises in providing advisory services across the full range of debt market including banking, capital market, asset-based lending, securitisation, project debt, senior debt, mezzanine financing, raising debt to finance LBOs or MBOs, acquisition financing and recapitalisation.

The team comprises veteran debt advisors with deep domain knowledge and understanding of the markets, this coupled with an extensive network of contacts with banks, financial institutions and other financial sponsors, provide solutions with optimal capital structures and most appropriate sources of finance.

Services Offered

- Syndication of Rupee Debt
- Foreign Currency Loan
- Acquisition Financing
- Project Finance
- Strategic Alliances
- Trade Finance
- Promoter Funding / ICDs
- Secured Loans
- Mezzanine Funding
- Asset Backed funding

Select Transactions



POWER
Atria Group, Bangalore

Structured Finance
Sole Arranger



Agrawal Group, Goa

Structured Finance
Sole Arranger



Asahi India

Rupee Term Loan
Sole Arranger



IPC Indo-Physo-Chemicals PRIVATE LTD.

Structured Finance
Sole Arranger



Calcom Cement

Rupee Term Loan
Sole Arranger



PRATAP UNIVERSITY
Maharana Pratap Education Society

Rupee Term Loan
Sole Arranger



PRATAP UNIVERSITY
Maharana Pratap Education Society

Acquisition Finance
Sole Arranger



Asahi India

ECB
Sole Arranger

Domain Focus

Special Situation Funding

We are committed to assisting companies navigating through difficult operating and financial environments.

Our clients include companies, financial sponsors, lenders, creditors and other interested parties in financially stressed situations and distressed transactions. Our overriding goal is to help maximize the value of a financially distressed company while protecting the business interest of the client.

We bring problem-solving skills, multi-product transaction expertise, understanding of industry and access to various sources of capital that are important in getting the companies back on their own feet.

Services Offered

One Time Settlement with lenders

Corporate Debt Restructuring

Restructuring & Re-financing

Distressed M&A

Sell off of divisions or recapitalisation

Management Buy-Outs/ Buy-Ins

Bridge Finance

Domain Focus

Cipher-Plexus operates across multiple domains, each with its own expert team and advisory partners. We have strong relationships with the top domestic and international companies as well as funds in each domain, ably led by a dedicated team of specialists with rich transaction experience within the sector.

Consumer and Agriculture



Energy & Environment



Healthcare and Life Sciences

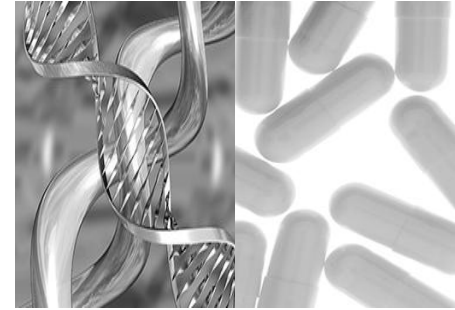

Logistics, Shipping and Infrastructure



Manufacturing and Engineering

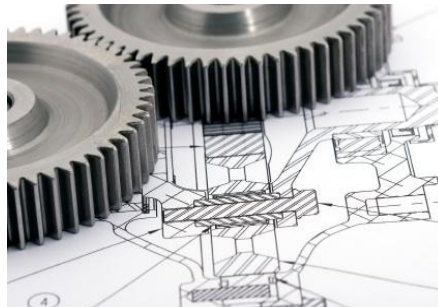

Technology, Media and Telecom



Consumer and Agriculture



Sub-sector focus

Food, beverages and restaurants

Specialty retail













Agri inputs and commodities

Home and personal care

Education

Consumer finance

Select Private Equity / Mergers and Acquisitions Transactions

 <p>A D Electronics Automation Product Distribution</p> <p>Acquisition by</p>  <p>Rexel</p>	 <p>Adiga's Group Quick Service Restaurants</p> <p>Investment by</p>  <p>New Silk Route</p>	 <p>MTR Foods Processed Indian Food</p> <p>Investment by</p>  <p>Aquarius (Singapore) & Associates</p>	 <p>CAREER LAUNCHER Inspiring leadership Career Launcher</p> <p>Education, Training, Research & Consultancy</p> <p>Investment by</p>  <p>Intel Capital</p>
 <p>CAREER LAUNCHER Inspiring leadership Career Launcher</p> <p>Education, Training, Research & Consultancy</p> <p>Acquired</p> <p>KITS Arun Roy Classes Lohana Test Series Compass Box Law School Tutorials</p>	 <p>Guardian Nutrition & Health Supplements Wholesale Cash & Carry</p> <p>Investment by</p>  <p>Samara Capital</p>	 <p>Ghari Group Detergents & Soaps FMCG</p> <p>Corporate Advisory</p>	 <p>Schroder Schroder Capital Partners Singapore</p> <p>Advisor for investment in</p>  <p>Vintage Cards & Creations (Greeting Cards)</p>













Environment and Energy



Sub-sector focus

- Energy generation
- Transmission and distribution
- Demand management
- Water management
- Solid waste management

Select Private Equity / Mergers and Acquisitions Transactions

 <p>Aqua Designs India Water Treatment EPC</p> <p>Investment by</p>  <p>Peepul Capital</p>	 <p>BGR Energy Systems Turnkey Engineering & Equipment Supply</p> <p>Investment by</p>  <p>Citibank Private Equity</p>	 <p>Hydroair Tectonics Water & Solid Waste Management</p> <p>Investment by</p>  <p>Clearwater Capital Partners</p>	 <p>Atria Group Renewable Energy IPP</p> <p>Investment by</p>  <p>BanyanTree Growth Capital-II</p>
 <p>Iris Energy Energy Efficiency Solutions</p> <p>Investment by</p>  <p>108 Plexus</p>	 <p>Spray Engineering Devices Energy Efficient Equipment</p> <p>Investment by</p> <p>New Vernon & Klondike Investments</p>	 <p>UEM Group Water Treatment EPC</p> <p>Investment by</p>  <p>India Value Fund</p>	 <p>Windsor Sathyam Wastewater Evaporator Manufacturing</p> <p>Strategic Investment By</p>  <p>Arvind Group</p>



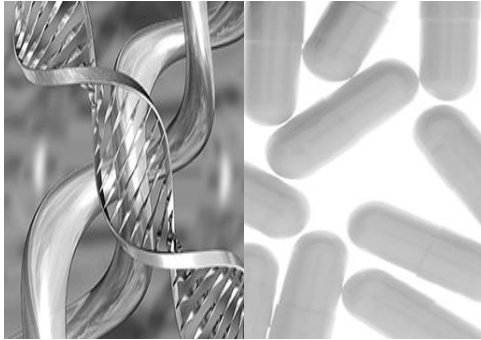









Healthcare and Life Sciences

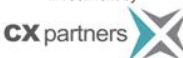

Sub-sector focus

Hospitals
 Radiology and pathology
 Medical devices
 Drug discovery, CRO
 Pharmaceuticals Nutraceuticals,
 Biotech
 Sterile liquids, Chemicals Allied
 services

Select Private Equity / Mergers and Acquisitions Transactions

 Sahyadri Hospitals <i>Multi Specialty Hospitals</i> Investment by  IDFC Project Equity	 Marck Biosciences <i>Pharmaceuticals - Sterile Liquids</i> Investment by  Tata Capital Healthcare Fund I	 Natco Pharma Limited <i>Integrated Pharmaceutical Company</i> Investment by  CX Partners	 Rubicon Research <i>Pharmaceutical R&D and Outsourcing</i> Investment by  Kotak Private Equity Group
 Hindustan Syringes & Medical Devices <i>Medical Devices & Disposables</i> Investment by Indocean Venture Advisors	 High Polymer Labs <i>Specialty Chemicals</i> Investment by  Templeton Asset Management	 Meghmani Organics <i>Agrochemicals, Dyestuff & Intermediates</i> Investment by JF Electra & ASC Capital	 Shasun Chemicals & Drugs <i>Pharmaceutical API</i> Investment by  GMO

Logistics, Shipping and Infrastructure

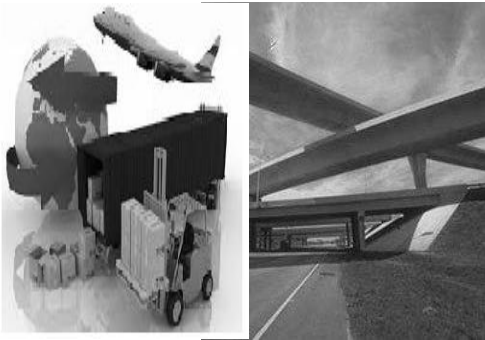

Sub-sector focus

Roads
Oil and gas
Ports
Metals and mining
Airports
Railways
Real estate and hospitality

Select Private Equity / Mergers and Acquisitions Transactions

 IVRCL Infrastructures & Projects Ltd. IVRCL Infrastructure & Projects <i>Infrastructure Development</i> Investment by  Citibank Private Equity & Chryscapital	 IVRCL Infrastructures & Projects Ltd. IVRCL Infrastructure & Projects <i>Infrastructure Development</i> Equity Placement by Strategic Investors	 JUSCO Jamshedpur <i>Utility & Engineering Services</i> Corporate Advisory	 Pratibha Industries <i>Infrastructure Services</i> Co-advisor for investment by  Reliance Capital
---	--	--	--

Manufacturing and Engineering

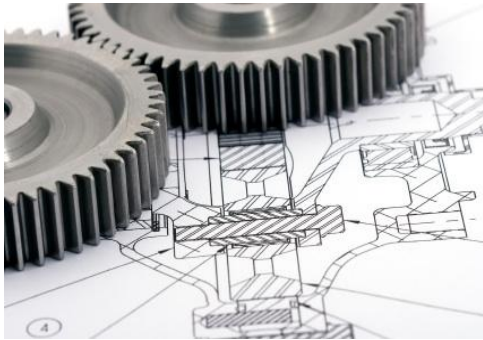

Sub-sector focus

Construction equipment
 Defence equipment
 Automotive and auto ancillaries
 Capital goods
 Industrial chemicals and polymers
 Aerospace

Select Private Equity / Mergers and Acquisitions Transactions

 Balkrishna Industries <i>Specialty Tyres</i> Investment by  Chryscapital	 Balkrishna Industries <i>Specialty Tyres</i> Investment by EVERCORE PARTNERS Evercore	 Precision Automation & Robotics <i>Robotics Applications</i> Investment by  HDFC	 Precision Automation & Robotics <i>Robotics Applications</i> Investment by  SICOM & Private Investors
 Shriram Bearings (Subsidiary of SRF) <i>Ball Bearings</i> Management buy-in by Mr. P. C. Sen	 Shriram Needle Bearings <i>Needle Roller Bearings</i> Acquired by  NRB Bearings	 SRF Ltd. & Robotics <i>Industrial Synthetics</i> Corporate Advisory & Restructuring	 Warburg Pincus & Mahansarias <i>Off-Highway Tyres</i> Financial Advisor for Financing & Acquisition of  ATG ALLIANCE TYRE GROUP Alliance Tyre Company

Technology Media and Telecom



Sub-sector focus

Online services / digital media

IT services, KPO, BPO

Mobile VAS

Payments processing















IT distribution

Cloud computing

Media, cable distribution

Telecom infrastructure

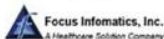
Select Private Equity / Mergers and Acquisitions Transactions

 <p>ACT Atria Convergence Technologies Digital Cable Distribution</p> <p>Investment by</p>  <p>INDIA VALUE FUND India Value Fund</p>	 <p>Bristlecone Bristlecone Inc. USA IT Consulting & Services</p> <p>Majority holding acquired by</p>  <p>Mahindra Mahindra Group</p>	 <p>ecs Electracard Services Payments Technology & Processing</p> <p>Strategic Investment by</p>  <p>Mastercard Worldwide</p>	 <p>Equinox Corp. USA Business Process Outsourcing</p> <p>Acquired by</p>  <p>iFlex Solutions</p>
 <p>Equinox Solutions USA Software Solutions</p> <p>Acquired by</p>  <p>CyberTech The Difference is Depth™ Cybertech Systems</p>	 <p>Momentum technologies Momentum India Software Solutions</p> <p>Investment by</p>  <p>Citi Citibank Private Equity</p>	 <p>NUANCE Nuance Communications USA Speech Solutions</p> <p>Acquired</p>  <p>Focus Infomatics, Inc. A Healthcare Solution Company Focus Infomatics</p>	 <p>RIS Result International Systems USA IT Enabled Services</p> <p>Acquired by</p>  <p>fiserv. Fiserv Inc.</p>

Global Reach

Global Reach

We have a wide global presence via our network of close associates across India & abroad.

Our valuable cross-border relationships in Japan, Europe and the US help provide a wide global reach to our clients.

Exploring cross-border synergies in our work is of high priority to us and these relationships enhance our global outlook and reach for our clients.



Leadership Team

Leadership Team



Ravi Saxena

Co-Founder and Managing Director
B. Tech (IIT Delhi), MBA (IIM Ahmedabad)

Ravi founded Cipher Capital in 1994, one of the earliest entrants as a boutique Investment Bank focused on Private Equity and M&A Advisory space. Over the last two decades he has built a robust track record of successful deals and enduring relationships founded on strong values and ethics.

His versatility and positivity coupled with his strong leadership skills help provide Cipher-Plexus a solid foundation as an organisation.

Prior to founding Cipher, Ravi worked with companies like Bajaj Auto, Tata Motors and JM Financial. At JM Financial, he led assignments for some of India's largest corporations.

Kunnaal Kumthekar

Co-Founder and Managing Director
B. E. (C.O.E.Pune), PGDBA (IMDR, Pune), Alumni of Wharton Business School

Kunnaal has successfully closed a number of private equity and M&A transactions and led many investment opportunities as an investment banker & a professional investor. He has the rare advantage of having Buy as well as Sell side experience that gives him a significant edge in the ability to structure and close deals. He provides overall leadership in execution at Cipher-Plexus.

Kunnaal had founded Plexus in 2005 and was also a co-founder of Nine Rivers Capital, the firms have been in Investment advisory business and managed SEBI registered domestic fund as well as advised Mauritius based offshore fund. Kunnaal continues to be on the Board of some of the Investee companies and provides strategic insights to them.

He was a partner with Cipher from 1997 till 2004. Kunnaal started his career with JM Financial and grew to Head - M&A and Corporate Advisory group, and then to become the CEO of the entire broking business.

Team



Team



Mehul Ramchandra

Executive Director

B. Com (University of Mumbai), CA (ICAI, Mumbai), MBA – Finance (ISB Hyderabad)

Mehul is part of the senior management team and his key strengths are in building and maintaining relationships with clients & investors, executing transactions and regulatory understanding.

In his ~25 years of experience in investment banking and financial consulting, he has worked on several fund raising / strategic transactions and also consulted with various domestic and multinational organizations in their India related strategy.

Prior to joining Cipher, he worked with Andersen & EY.



Rajat Agrawal

Associate Director

B.Com (University of Mumbai), CA (ICAI, Mumbai), Executive MBA in Finance (NMIMS, Mumbai), CFA (CFA Institute USA)

Rajat has around 9 years of Business Development & Execution experience in Investment Banking, about 7 years of experience in Equity Research & 5 years of Industry Experience.

His core experience has been in domains across Consumer brands, NBFC's, Education, Industrials, Textile consumables, Hospitality, Solar power, Logistics, Healthcare, among others.

Prior to joining Cipher-Plexus, he was Vice President with Value Vision Consultants wherein his role comprised of both business development and execution. He has also worked with MX Capital as an Associate in Investment Banking

Team



Mudit Trivedi

Associate Director
B.Sc., Multimedia and UI/UX Design

Mudit has over 14 years of rich experience in business development, strategic partnerships, and relationship management across public and private sectors. He has been a part of the tech industry since 2010, leveraging his expertise to drive growth and innovation.

His leadership and relationship skills coupled with an ability to connect with diverse set of stakeholders helps foster strategic alliances and deliver impactful results. Mudit's deep understanding of startups, SMEs and established family businesses helps deliver tailored strategies to address challenges, unlock value and scale effectively through boutique investment banking solutions.



Dhruv Saxena

Associate Director
B Chem Engg., (UDCT Mumbai)

Dhruv has about four years experience in Investment banking. At Cipher-Plexus he anchors start-ups and supplements business development and execution in PE, M&A space. He has 6.5 years of rich experience in the polymer industry coupled with having a strong overarching experience in the Oil & Gas/Energy space. Prior to joining us, Dhruv has worked with ExxonMobil on various global assignments across different functions. He has worked very closely with senior management in financial planning for their flagship chemical business at their Houston Campus. He has also worked on the commercial side in the domestic Polyethylene market managing major markets of Daman and Tamil Nadu.

Team



Gaurav Kriplaani

Vice President

CA (ICAI), *Fintech Innovations Specialisation (University of Michigan)*

Gaurav has about 12 years work experience as a technology investment banker and forensic investigations specialist with experience across capital raising, strategic investments, and dispute advisory. He has led advisory work at Trigintillion.one and oversaw investigations and economic damages analysis at Konverj-Zeus.

His background includes senior roles in forensic audits, due diligence, and risk advisory at Mazars, BDO, KPMG, and founding experience at AdvaRisk, working with private equity firms, lenders, and corporates across fintech, Web3, healthcare, and IT.



Abhishek Agrawal

Vice President

CA (ICAI), CFA (CFA Institute, USA), B.Com (Hons) (Calcutta University)

Abhishek has about 7 years of experience in Investment Banking with strong execution skills in IB and SME IPO and has worked across domains such as Consumer, Technology, Wellness, Engineering, etc.

Prior to joining us, Abhishek was working with Virtuous Capital Ltd as Sr, Associate working on end to end origination & execution of PE, M&A Transactions.



Anand Mukunda Rajan

Vice President

MSc., Finance, (Imperial College, London), MA., (with Hons.)-Economics with Finance (The University of Edinburgh)

Anand has about 7 years of rich IB experience in Business Development and Execution in PE, M&A verticals in the Consumer, Healthcare & Pharma. He also supplements in the start-up space across sectors.

Prior to joining Cipher-Plexus, he interned with CIMB Investment Bank Pte Ltd, and before that India Infoline in their equity desk and JLT Asia Singapore Pte Ltd.

Team



Somil Shah

Senior Associate

CA (ICAI), M.Com (IGNOU), B.Com (HR College, Mumbai)

Somil has about ~5 years work experience in financial services and consulting domain in research and execution across multiple sectors. At Cipher-Plexus, Somil supports the core team in desk research, analysis and execution in IB segment.

Prior to joining Cipher-Plexus, he worked with TresVista Financials, Hindustan Lever, Mazars India LLP & BDO India LLP.



Jainam Shah

Associate

CFA (Level 1), Bachelor of Management Studies (Finance), Mithibai College Mumbai

At Cipher-Plexus Jainam supports the core team in execution in the IB segment.

Prior to joining Cipher-Plexus, Jainam worked with CRISIL, Tristone Strategic Partners and TresVista Financial Services.

Team



Kritin Pruthi

Analyst

B.Sc. Finance (NMIMS, Mumbai)

At Cipher-Plexus Kritin supports the core team in desk research, data analysis and execution in the IB segment.

Prior to joining Cipher-Plexus, Kritin worked with TresVista Financial Services as a Research and Investment Analyst, interned with Virtuous Capital, Bathiya & Associates LLP, J. Walter Thompson



Rohil Khakhar

Analyst

CA (ICAI), M.Com (University of Mumbai) B.Com (HR College, Mumbai)

At Cipher-Plexus Rohil supports the core team in desk research, data analysis and execution in the IB segment.

Prior to joining Cipher-Plexus, Rohil worked with P4 Capital as an Associate and did his articles with Price Waterhouse Chartered Accountants LLP (PwC), Mumbai

Contact Us

Cipher-Plexus Capital Advisors Pvt. Ltd.

1111 -1112, Building 11, 1st floor, Solitaire Corporate Park,
Chakala, Andheri (E), Mumbai - 400093
Maharashtra, India

Tel: +91 22 6777 4777 | Email: info@cipherplexus.in



● Mumbai Office

★ International Partners