



# Cipher–Plexus Capital Advisors Pvt. Ltd.

---

[www.cipherplexus.in](http://www.cipherplexus.in)

# Overview

---

# Cipher-Plexus Capital

Three Decades  
of Experience



Led by Veteran  
Deal Makers



15+ Team and  
Partners with  
Exceptional  
Camaraderie



Track Record of  
over 100+ Deals

- › Headquartered in Mumbai, Cipher-Plexus was formed with the integration of Cipher Capital & Plexus Ventures
- › Rich experience of three decades provides significant edge to protect & serve the best interests of its clients

- › Diversity of experience coupled with global reach & a culture founded on virtues enhances the ability to deliver superior value
- › 15+ Team members and Partners have been part of bulge-bracket investment banks

- › Insights from over 100+ successful transactions consummated across sectors, sizes, stages & complexities

Insights of over three decades and over 100+ successful deal closures ...

## Business & Services

---

# Private Equity

---

We enjoy a wide reach of high quality relationships and an admirable reputation with some of the most respected and sought after investors.

Our close interactions with all significant private equity and venture capital investors on an ongoing basis have helped us develop a deep understanding of their culture, functioning, investment philosophy and preferences. This facilitates the most appropriate investor-company fit towards delivering the best value in the given context.

Strong execution orientation & capabilities help us culminate difficult and complex transactions successfully & speedily.

## Services Offered

- Growth/Expansion Capital
- Equity Financing
- Mezzanine Funding
- PIPEs
- Secondary Funding
- Special Situation Funding
- Buyouts
- Acquisition Financing

# Select Transactions



**Marck Biosciences**  
Pharmaceuticals - Sterile Liquids

Investment by  
**TATA CAPITAL**  
Private Equity

Tata Capital Healthcare Fund I



**Adiga's Group**  
Quick Service Restaurants

Investment by  
**nsr | new silk route**  
GROWTH CAPITAL

New Silk Route



**Sahyadri Hospitals**  
Multiple Specialty Hospitals

Investment by  
**IDFC**

IDFC Project Equity



**BGR Energy Systems**  
Turnkey Engineering & Equipment Supply

Investment by  
**citi**

Citibank Private Equity



**Warburg Pincus & Mahansarias**  
Off-Highway Tyres

Financial Advisor for Financing & Acquisition of  
**ATG**  
ALLIANCE TYRE GROUP

Alliance Tyre Company



**MTR Foods**  
Processed Indian Food

Investment by  
**AQUARIUS**  
INVESTMENT ADVISORS PTE. LTD.  
Aquarius (Singapore) & Associates



**JMT Auto**  
Auto Ancillaries

Investment by  
**CHRYSCAPITAL**

ChrysCapital



**UEM Group**  
Water Treatment EPC

Investment by  
**INDIA VALUE FUND**

India Value Fund



**Balkrishna Industries**  
Specialty Tyres

Investment by  
**EVERCORE PARTNERS**

Evercore



**Rubicon Research**  
Pharmaceutical R&D and Outsourcing

Investment by  
**kotak**  
Private Equity

Kotak Private Equity Group



**Atria Convergence Technologies**  
Digital Cable Distribution

Investment by  
**INDIA VALUE FUND**

India Value Fund



**Guardian Nutrition & Health Supplements**  
Wholesale Cash & Carry

Investment by  
**SAMARA CAPITAL**

Samara Capital



**Meghmani Organics Limited Ahmedabad, India**  
Agro-chemicals, Dyestuff and Intermediates

Investment by  
Rajasthan Global Securities Pvt Ltd

# Select Relationships

ASCENT CAPITAL



THE CARLYLE GROUP



Creador®



EVERSTONE



Goldman Sachs



KKR



Morgan Stanley  
Global Private Equity



MULTIPLES

NORWEST VENTURE PARTNERS



SAIFPartners®



SEQUOIA



TATA CAPITAL  
Private Equity

TEMASEK



WARBURG PINCUS

# Mergers and Acquisitions

---

We represent clients on the sell-side as well as buy-side leveraging our deep relationships, rich experience and insights in managing complex cross border and domestic transactions.

The team has a strong domain focus and knowledge of the ecosystem that coupled with our expertise in structuring help us unlock the true potential in each transaction. We work skilfully with a diverse set of banks, investors, other financial sponsors and agencies to consummate the transaction efficiently.

We have strong relationships in India, US, Europe, Japan, and Middle East which help in zeroing on to the right potential targets for the clients.

## Services Offered

Domestic sell-side and buy-side transactions

Cross border M&A representing sell-side as well as buy-side

Divestitures and Spin-offs

Carve-outs

Strategic Alliances

Joint Ventures

Management Buy-outs

Leveraged Buy-outs

Management Buy-ins



# Select Transactions

**WARBURG PINCUS**

Warburg Pincus & Mahansarias  
Off-Highway Tyres

Financial Advisor, Financing & Acquisition of

**ATG**  
ALLIANCE TYRE GROUP  
Alliance Tyre Company

**ecs**

Electracard Services  
Payments Technology & Processing

Strategic Investment by

**Mastercard Worldwide**

**NUANCE**

Nuance Communications USA  
Speech Solutions

Acquired

**Focus Informatics, Inc.**  
A Healthcare Solution Company  
Focus Informatics

**Windsor Sathyam**

Wastewater Evaporator Manufacturing

Strategic Investment By

**ARVIND**  
Arvind Group

**Equinox Solutions USA**  
Software Solutions

Acquired by

**CyberTech**  
The Difference is Depth  
Cybertech Systems

**Bristlecone**

Bristlecone Inc. USA  
IT Consulting & Services

Majority holding acquired by

**Mahindra**  
Mahindra Group

**RIS**

Result International Systems USA  
IT Enabled Services

Acquired by

**fiserv.**  
Fiserv Inc.

**A D Electronics**

Automation Product Distribution

Sole Financial Advisor for Acquisition by

**REXEL**  
REXEL GROUP SA  
Rexel

**CAREER LAUNCHER**  
Inspiring leadership  
Career Launcher

Education, Training, Research & Consultancy

Acquired

KITS  
Arun Roy Classes  
Lohana Test Series  
Compass Box  
Law School Tutorials

**Optimum Solutions**  
empowering careers with technology  
IT Solutions and Services

Investment by

**ABeam Consulting**  
ABeam Consulting®

**equinox**

Equinox Corp. USA  
Business Process Outsourcing

Acquired by

**i-flex**  
iFlex Solutions

**घड़ी**

Ghari Group  
Detergents & Soaps FMCG

Corporate Advisory

**OGP**

Orient Green Power Company Limited  
Chennai, India  
Renewable Energy

Sale of Co-gen Power Plant to DY Patil

# Structured Funding and Debt Advisory

---

Our Debt Advisory team specialises in providing advisory services across the full range of debt market including banking, capital market, asset-based lending, securitisation, project debt, senior debt, mezzanine financing, raising debt to finance LBOs or MBOs, acquisition financing and recapitalisation.

The team comprises veteran debt advisors with deep domain knowledge and understanding of the markets, this coupled with an extensive network of contacts with banks, financial institutions and other financial sponsors, provide solutions with optimal capital structures and most appropriate sources of finance.

## Services Offered

- Syndication of Rupee Debt
- Foreign Currency Loan
- Acquisition Financing
- Project Finance
- Strategic Alliances
- Trade Finance
- Promoter Funding / ICDs
- Secured Loans
- Mezzanine Funding
- Asset Backed funding

# Select Transactions



**POWER**  
**Atria Group, Bangalore**

**Structured Finance**  
*Sole Arranger*



**Agrawal Group, Goa**

**Structured Finance**  
*Sole Arranger*



**Asahi India**

**Rupee Term Loan**  
*Sole Arranger*



**IPC** Indo-Physo-Chemicals PRIVATE L10.

**Structured Finance**  
*Sole Arranger*



**CALCOM CEMENT**  
Calcom Cement

**Rupee Term Loan**  
*Sole Arranger*



**PRATAP UNIVERSITY**  
Maharana Pratap Education Society

**Rupee Term Loan**  
*Sole Arranger*



**PRATAP UNIVERSITY**  
Maharana Pratap Education Society

**Acquisition Finance**  
*Sole Arranger*



**Asahi India**

**ECB**  
*Sole Arranger*

## Domain Focus

---

# Special Situation Funding

---

We are committed to assisting companies navigating through difficult operating and financial environments.

Our clients include companies, financial sponsors, lenders, creditors and other interested parties in financially stressed situations and distressed transactions. Our overriding goal is to help maximize the value of a financially distressed company while protecting the business interest of the client.

We bring problem-solving skills, multi-product transaction expertise, understanding of industry and access to various sources of capital that are important in getting the companies back on their own feet.

## Services Offered

- One Time Settlement with lenders
- Corporate Debt Restructuring
- Restructuring & Re-financing
- Distressed M&A
- Sell off of divisions or recapitalisation
- Management Buy-Outs/ Buy-Ins
- Bridge Finance

# Domain Focus

Cipher-Plexus operates across multiple domains, each with its own expert team and advisory partners. We have strong relationships with the top domestic and international companies as well as funds in each domain, ably led by a dedicated team of specialists with rich transaction experience within the sector.

Consumer and Agriculture



Energy & Environment



Healthcare and Life Sciences



Logistics, Shipping and Infrastructure



Manufacturing and Engineering

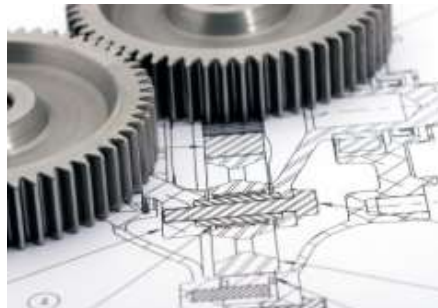

Technology, Media and Telecom

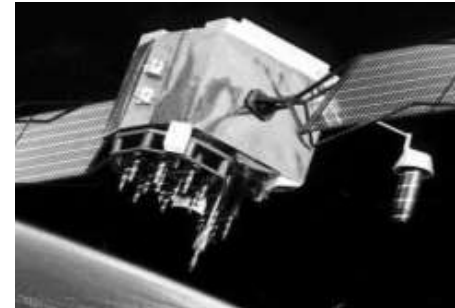

# Consumer and Agriculture



## Select Private Equity / Mergers and Acquisitions Transactions

### Sub-sector focus

Food, beverages and restaurants

Specialty retail

Agri inputs and commodities

Home and personal care

Education

Consumer finance

 <p><b>A D Electronics</b> Automation Product Distribution</p> <p>Acquisition by  Rexel</p>	 <p><b>Adiga's Group</b> Quick Service Restaurants</p> <p>Investment by    <b>new silk route</b> New Silk Route</p>	 <p><b>MTR Foods</b> Processed Indian Food</p> <p>Investment by  Aquarius (Singapore) &amp; Associates</p>	 <p><b>CAREER LAUNCHER</b> Inspiring leadership Career Launcher Education, Training, Research &amp; Consultancy</p> <p>Investment by  Intel Capital</p>
 <p><b>Career Launcher</b> Education, Training, Research &amp; Consultancy</p> <p>Acquired <b>KITS</b> Arun Roy Classes Lohana Test Series Compass Box Law School Tutorials</p>	 <p><b>Guardian Nutrition &amp; Health Supplements</b> Wholesale Cash &amp; Carry</p> <p>Investment by  Samara Capital</p>	 <p><b>Ghari Group</b> Delegants &amp; Soups FMCG</p> <p>Corporate Advisory</p>	 <p><b>Schroder Capital Partners Singapore</b></p> <p>Advisor for investment in  Vintage Cards &amp; Creations (Greeting Cards)</p>

# Environment and Energy



## Sub-sector focus

- Energy generation
- Transmission and distribution
- Demand management
- Water management
- Solid waste management

## Select Private Equity / Mergers and Acquisitions Transactions

 <b>Aqua Designs India</b> Water Treatment EPC  Investment by  <b>Peepul Capital</b>	 <b>BGR Energy Systems</b> Turkey Engineering & Equipment Supply  Investment by  <b>Citibank Private Equity</b>	 <b>Hydroair Tectonics</b> Water & Solid Waste Management  Investment by  <b>Clearwater Capital Partners</b>	 <b>Atria Group</b> Renewable Energy IPP  Investment by  <b>BanyanTree Growth Capital-II</b>
 <b>Iris Energy</b> Energy Efficiency Solutions  Investment by  <b>108 Plexus</b>	 <b>Spray Engineering Devices</b> Energy Efficient Equipment  Investment by <b>New Vernon &amp; Klondike Investments</b>	 <b>UEM Group</b> Water Treatment EPC  Investment by  <b>India Value Fund</b>	 <b>Windsor Sathyam</b> Wastewater Evaporator Manufacturing  Strategic Investment By  <b>Arvind Group</b>



# Healthcare and Life Sciences



## Sub-sector focus

Hospitals

Radiology and pathology

Medical devices

Drug discovery, CRO

Pharmaceuticals Nutraceuticals,

Biotech

Sterile liquids, Chemicals Allied services

## Select Private Equity / Mergers and Acquisitions Transactions

 Sahyadri Hospitals Multi Specialty Hospitals Investment by  IDFC Project Equity	 Marck Biosciences Pharmaceuticals - Sterile Liquids Investment by  Tata Capital Healthcare Fund I	 NATCO Pharma Limited Integrated Pharmaceutical Company Investment by  CX Partners	 Rubicon Research Pharmaceutical R&D and Outsourcing Investment by  Kotak Private Equity Group
 Hindustan Syringes & Medical Devices Medical Devices & Disposables Investment by Indocean Venture Advisors	 High Polymer Labs Specialty Chemicals Investment by  Templeton Asset Management	 Meghmani Organics Agrochemicals, Dyesstuff & Intermediates Investment by JF Electra & ASC Capital	 Shasun Chemicals & Drugs Pharmaceutical API Investment by  GMO

# Logistics, Shipping and Infrastructure

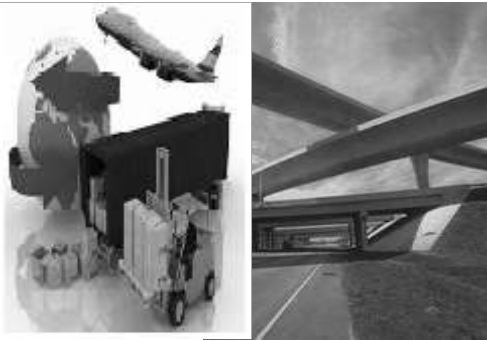

## Sub-sector focus

- Roads
- Oil and gas
- Ports
- Metals and mining
- Airports
- Railways
- Real estate and hospitality

## Select Private Equity / Mergers and Acquisitions Transactions

<p>IVRCL Infrastructure &amp; Projects Ltd. IVRCL Infrastructure &amp; Projects Infrastructure Development</p> <p>Investment by</p> <p>Citibank Private Equity &amp; Chryscapital</p>	<p>IVRCL Infrastructure &amp; Projects Ltd. IVRCL Infrastructure &amp; Projects Infrastructure Development</p> <p>Equity Placement by</p> <p>Strategic Investors</p>	<p>JUSCO Jamshedpur Utility &amp; Engineering Services</p> <p>Corporate Advisory</p>	<p>Pratibha Industries Infrastructure Services</p> <p>Co-advisor for investment by</p> <p>RELIANCE Reliance Capital</p>
---	--	--	---

# Manufacturing and Engineering

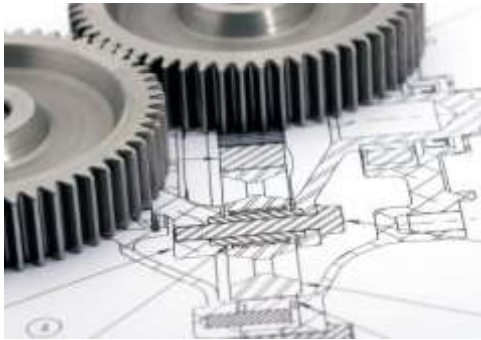

## Sub-sector focus

- Construction equipment
- Defence equipment
- Automotive and auto ancillaries
- Capital goods
- Industrial chemicals and polymers
- Aerospace

## Select Private Equity / Mergers and Acquisitions Transactions

 <b>Balkrishna Industries</b> <i>Specialty Tyres</i>  <i>Investment by</i>  <b>ChryCapital</b>	 <b>Balkrishna Industries</b> <i>Specialty Tyres</i>  <i>Investment by</i> <b>EVERCORE PARTNERS</b> <b>Evercore</b>	 <b>Precision Automation &amp; Robotics</b> <i>Robotics Applications</i>  <i>Investment by</i>  <b>HDFC</b>	 <b>Precision Automation &amp; Robotics</b> <i>Robotics Applications</i>  <i>Investment by</i>  <b>SICOM &amp; Private Investors</b>
 <b>Shriram Bearings (Subsidiary of SRF)</b> <i>Ball Bearings</i>  <i>Management Buy-out by</i>  <b>Mr. P. C. Sen</b>	 <b>Shriram Needle Bearings</b> <i>Needle Roller Bearings</i>  <i>Acquired by</i>  <b>NRB Bearings</b>	 <b>SRF Ltd. &amp; Robotics</b> <i>Industrial Synthetics</i>  <i>Corporate Advisory &amp; Restructuring</i>	 <b>Warburg Pincus &amp; Mahansarias</b> <i>Off-Highway Tyres</i>  <i>Financial Advisor for Financing &amp; Acquisition of</i>  <b>ATG</b> <b>Alliance Tyre Company</b>



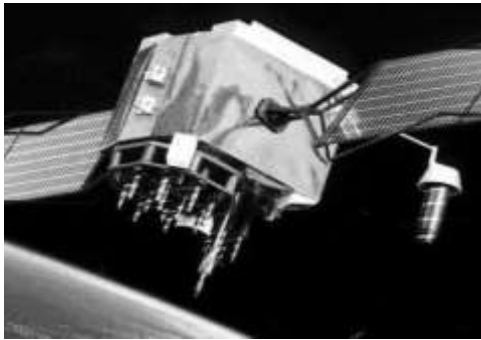





# Technology Media and Telecom



## Sub-sector focus

Online services / digital media  
 IT services, KPO, BPO  
 Mobile VAS  
 Payments processing  
 IT distribution  
 Cloud computing  
 Media, cable distribution  
 Telecom infrastructure

## Select Private Equity / Mergers and Acquisitions Transactions

 <b>ACT</b> Atria Convergence Technologies Digital Cable Distribution  Investment by  <b>INDIA VALUE FUND</b> India Value Fund	 <b>Bristlecone</b> Bristlecone Inc. USA IT Consulting & Services  Majority holding acquired by  <b>Mahindra</b> Mahindra Group	 <b>ecs</b> Electracard Services Payments Technology & Processing  Strategic investment by  <b>Mastercard Worldwide</b>	 <b>Equinox</b> Equinox Corp. USA Business Process Outsourcing  Acquired by  <b>iflex</b> iFlex Solutions
 <b>Equinox Solutions USA</b> Software Solutions  Acquired by  <b>CyberTech</b> The Difference is Depth Cybertech Systems	 <b>Momentum Technologies</b> Momentum India Software Solutions  Investment by  <b>citi</b> Citibank Private Equity	 <b>NUANCE</b> Nuance Communications USA Speech Solutions  Acquired by  <b>Focus Infomatics, Inc.</b> A Healthcare Enabler Company Focus Infomatics	 <b>RIS</b> Result International Systems USA IT Enabled Services  Acquired by  <b>fiserv.</b> Fiserv Inc.

Global Reach

---

# Global Reach

---

We have a wide global presence via our network of close associates across India & abroad.

Our valuable cross-border relationships in Japan, Europe and the US help provide a wide global reach to our clients.

Exploring cross-border synergies in our work is of high priority to us and these relationships enhance our global outlook and reach for our clients.



## Leadership Team

---

# Leadership Team

---



## **Ravi Saxena**

Co-Founder and Managing Director  
*B. Tech (IIT Delhi), MBA (IIM Ahmedabad)*

Ravi founded Cipher Capital in 1994, one of the earliest entrants as a boutique Investment Bank focused on Private Equity and M&A Advisory space. Over the last two decades he has built a robust track record of successful deals and enduring relationships founded on strong values and ethics.

His versatility and positivity coupled with his strong leadership skills help provide Cipher-Plexus a solid foundation as an organisation.

Prior to founding Cipher, Ravi worked with companies like Bajaj Auto, Tata Motors and JM Financial. At JM Financial, he led assignments for some of India's largest corporations.



## **Kunal Kumthekar**

Co-Founder and Managing Director  
*B. E. (C.O.E.Pune), PGDBA (IMDR, Pune), Alumni of Wharton Business School*

Kunal has successfully closed a number of private equity and M&A transactions and led many investment opportunities as an investment banker & a professional investor. He has the rare advantage of having Buy as well as Sell side experience that gives him a significant edge in the ability to structure and close deals. He provides overall leadership in execution at Cipher-Plexus.

Kunal had founded Plexus in 2005 and was also a co-founder of Nine Rivers Capital, the firms have been in Investment advisory business and managed SEBI registered domestic fund as well as advised Mauritius based offshore fund. Kunal continues to be on the Board of some of the Investee companies and provides strategic insights to them.

He was a partner with Cipher from 1997 till 2004. Kunal started his career with JM Financial and grew to Head - M&A and Corporate Advisory group, and then to become the CEO of the entire broking business.



Team



# Team

---



## **Mehul Ramchandra**

Executive Director

*B. Com (University of Mumbai), CA (ICAI, Mumbai), MBA – Finance (ISB Hyderabad)*

Mehul is part of the senior management team and his key strengths are in building and maintaining relationships with clients & investors, executing transactions and regulatory understanding.

In his ~24 years of experience in investment banking and financial consulting, he has worked on several fund raising / strategic transactions and also consulted with various domestic and multinational organizations in their India related strategy.

Prior to joining Cipher, he worked with Andersen & EY.



## **Rajat Agrawal**

Associate Director

*B.Com (University of Mumbai), CA (ICAI, Mumbai), Executive MBA in Finance (NMIMS, Mumbai), CFA (CFA Institute USA)*

Rajat has around 9 years of Business Development & Execution experience in Investment Banking, about 7 years of experience in Equity Research & 5 years of Industry Experience.

His core experience has been in domains across Consumer brands, NBFC's, Education, Industrials, Textile consumables, Hospitality, Solar power, Logistics, Healthcare, among others.

Prior to joining Cipher-Plexus, he was Vice President with Value Vision Consultants wherein his role comprised of both business development and execution. He has also worked with MX Capital as an Associate in Investment Banking

# Team

---



## **Suresh Dhumale**

Vice President

*B.E-Chemical Engg. (UDCT, Mumbai), PGDM (IIM Ahmedabad)*

Suresh has ~14 years experience in Investment Banking, Corporate Strategy & Finance with strong experience of transaction life cycle & many successful deal closures. He has closely worked with Top Management (CXOs) on various assignments from fund raising to process improvement to turnaround. Prior to joining us, Suresh was working with 7i Capital Advisors as AVP, and before that, with Veliing Holdings Ltd., Mauritius, Thomas Cook India, Gammon India Ltd., Digicable Network & BPCL.



## **Dhruv Saxena**

Vice President

*B Chem Engg., (UDCT Mumbai)*

Dhruv has about couple of year's experience in Investment banking. At Cipher-Plexus he anchors start-ups and supplements business development and execution in PE, M&A space. He has 6.5 years of rich experience in the polymer industry coupled with having a strong overarching experience in the Oil & Gas/Energy space.

Prior to joining us, Dhruv has worked with ExxonMobil on various global assignments across different functions. He has worked very closely with senior management in financial planning for their flagship chemical business at their Houston Campus. He has also worked on the commercial side in the domestic Polyethylene market managing major markets of Daman and Tamil Nadu.



## **Abhishek Agrawal**

Vice President

*CA (ICAI), CFA (CFA Institute, USA), B.Com (Hons) (Calcutta University)*

Abhishek has about 7 years of experience in Investment Banking with strong execution skills in IB and SME IPO and has worked across domains such as Consumer, Technology, Wellness, Engineering, etc.

Prior to joining us, Abhishek was working with Virtuous Capital Ltd as Sr, Associate working on end to end origination & execution of PE, M&A Transactions.

# Team

---



**Anand Mukunda Rajan**

Assistant Vice President

*MSc., Finance,(Imperial College, London), MA., (with Hons.)-Economics with Finance (The University of Edinburgh)*

Anand has about 6 years of rich IB experience in Business Development and Execution in PE, M&A verticals in the Consumer, Healthcare & Pharma. He also supplements in the start-up space across sectors.

Prior to joining Cipher-Plexus, he interned with CIMB Investment Bank Pte Ltd, and before that India Infoline in their equity desk and JLT Asia Singapore Pte Ltd.



**Vishwa Shah**

Analyst

*CA (ICAI), B.Com (HR College, Mumbai)*

Vishwa supports the core team in desk research, analysis and execution in IB & SME segments.

Prior to joining Cipher-Plexus, he completed his Articleship and Industrial training with Apollo Global Management INC, Mumbai and with PWC, Mumbai



**Kritin Pruthi**

Analyst

*B.Sc. Finance (NMIMS, Mumbai)*

Kritin supports the core team in desk research, data analysis and execution in the IB segment.

Prior to joining Cipher-Plexus, Kritin worked with TresVista Financial Services as a Research and Investment Analyst, interned with Virtuous Capital, Bathiya & Associates LLP, J. Walter Thompson

# Contact Us

---

## Cipher-Plexus Capital Advisors Pvt. Ltd.

Unit 1, Building 11, 1<sup>st</sup> floor, Solitaire Corporate Park,  
Chakala, Andheri (E), Mumbai - 400093  
Maharashtra, India

Tel: +9122 6777 4777 | Fax: +9122 6777 4778

Email: [info@cipherplexus.in](mailto:info@cipherplexus.in)



● Mumbai Office

★ International Partners